

# **ESSER**

Operating and Installation Manual  
essertronic<sup>®</sup> 3002 serie 02  
Fire Alarm Control Panel

# Contents

Page

<b>1. Operating Manual</b> . . . . .	<b>3</b>
1.1. Operating panel . . . . .	4
1.2. Enabling operating panel . . . . .	4
1.3. Disconnecting/resetting of detector zones . . . . .	5
1.4. Disconnecting/resetting the master box (MFAB) / relay output . . . . .	5
1.5. Fire alarm . . . . .	6
1.6. Delay/verify . . . . .	8
1.7. Alarm counter . . . . .	9
1.8. Lamp test . . . . .	9
1.9. <b>Common Trouble and CPU failure</b> . . . . .	10
<b>2. Installation Manual</b> . . . . .	<b>15</b>



key pressed



key not pressed



LED off



LED flashing



LED lit

} operating panel indicators

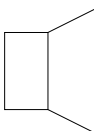

continuous tone

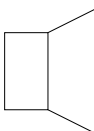

intermittent

} panel buzzer



Important note

# ESSER

## 1. Operating Manual

### General

The compact, microprocessor-controlled essertronic® 3002 fire alarm control panel is designed to be used preferably in small to medium-sized projects for the early detection of fire in conjunction with conventional automatic detectors and manual call points.

Its clearly structured design enables the operator or specially instructed person to operate the panel functions with ease and speed.

The operating status of each detector zone, such as fire, trouble or disconnection, is shown on the operating panel by individual detector zone indicators.

If a master box is connected for transmission of an alarm to any central station, e.g., fire department, an output is provided for the operation of a "fire department operating panel" (FDOP) and fire department key box (FSK).

These operating and installation instructions provide a basis for understanding explanations from your specialized installer.

The first section (operation) describes the indicators and controls that are important to operate the fire alarm control panel.

The second section (installation) is intended exclusively for the installer or customer/maintenance service.



If the fire alarm control panel is already installed, control actions may only be performed by authorized personnel in observance of security precautions and in coordination with the central station.

**Observe entries in the log book !**

## 1.1. Operating panel

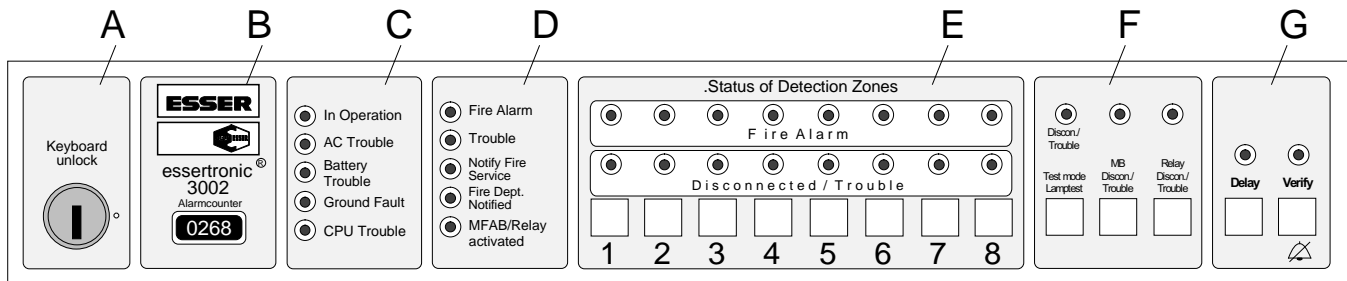

- A** Key switch for enabling key pad
- B** Alarm counter
- C** Operating mode indicators
- D** Common indicators

- E** Detector zone section
- F** Function keys/ common switch-off disconnected
- G** Special functions

## 1.2. Enabling operating panel

Key switch set to horizontal position  
key pad enabled

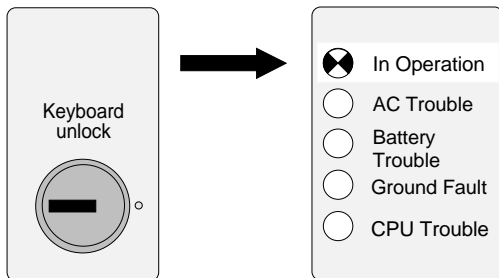

Key switch set to vertical position  
key pad inhibited

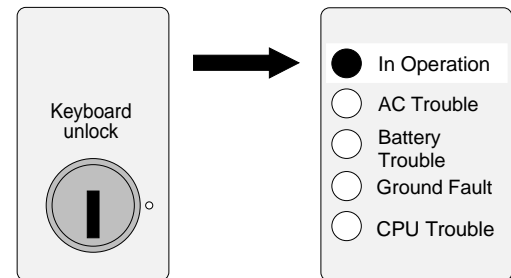

The - buzzer off (verify) - key is also operational when the key pad is inhibited.

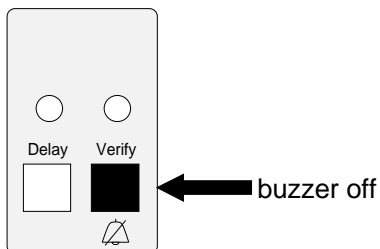

 The master box is automatically disconnected when the key pad is enabled. Disconnections must be entered in the log book.

## 1.3. Disconnecting/resetting of detector zones

Example: Detector zone 5

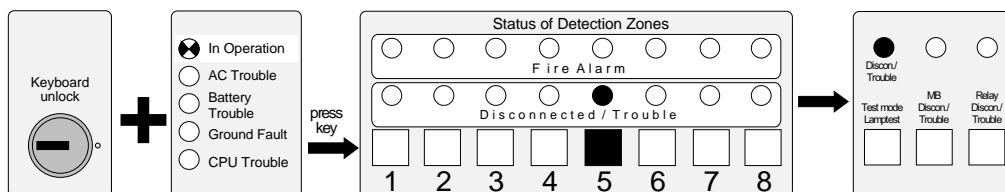

- Use key switch to enable key pad for operation
- Green LED *In Operation* will flash
- Press key for the detector zone you wish to disconnect/reset (alternating function)
- Yellow, steadily lit LED indicates the disconnected detector zone
- yellow steadily lit LED indicates the common switch-off

☞ A disconnected detector zone will not signal any alarm in the event of an incident.

## 1.4. Disconnecting/resetting the master box (MFAB) / relay output

**MFAB** ⇒ master box for relaying alarm to central station, e.g. fire department

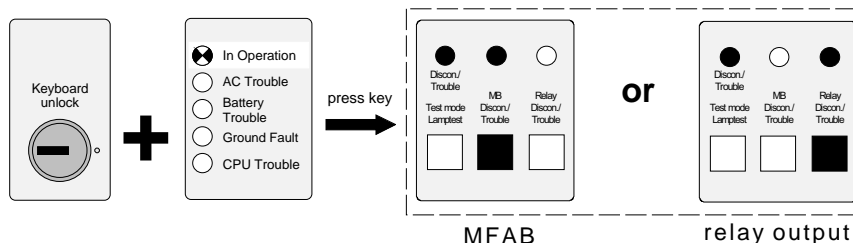

**Relay** ⇒ relay output for activating remote, visual or audible alarm devices

- Enable key pad
- Green LED - In Operation - will flash
- Press key for MFAB and/or relay output (you wish to disconnect/reset)
- Yellow LED for the disconnected output light up continuously
- yellow LED - common switch-off light up continuously

☞ A disconnected MFAB or relay output will not be activated in the case of an event !

## 1.5. Fire alarm

Example: Detector zone 3

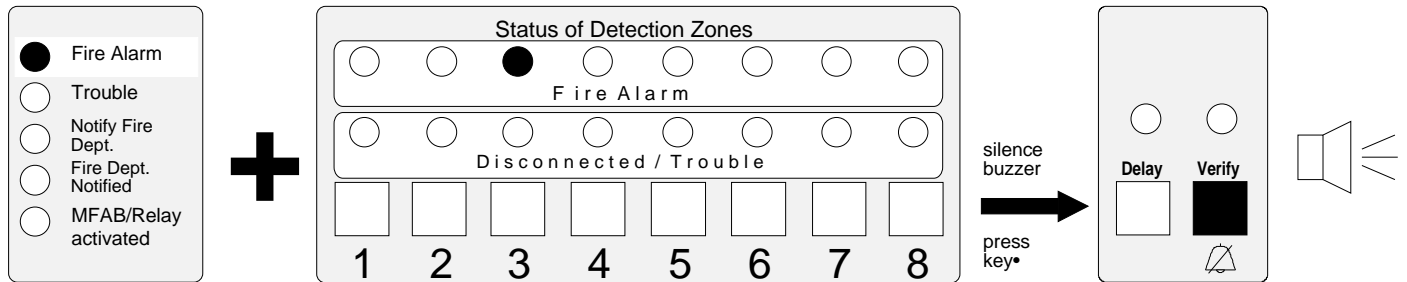

- Red LED in common indicator section will be continuously lit
- Red LED for triggered detector zone will be continuously lit
- Red LED for triggered detector zone will flash at detector zone that first signaled fire alarm (first alarm identification)
- Panel buzzer and master box (if fitted) will be activated

### Indicators for master box

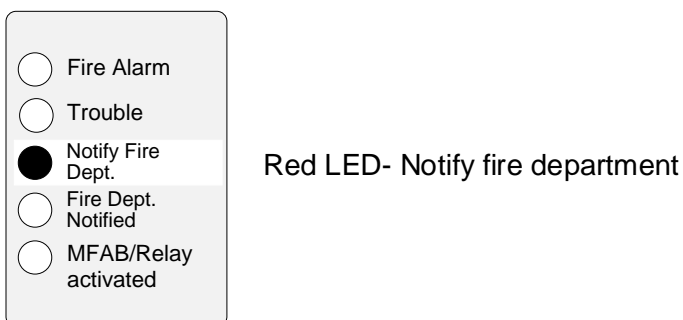

Master box is malfunctioning or disconnected and cannot be activated.

 **Fire department must be notified immediately!**

# ESSER

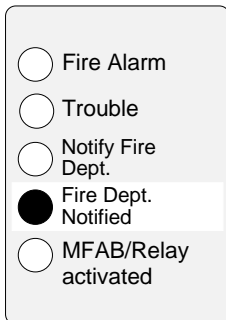

Red LED- Fire department is notified

- Master box was triggered
- The intervention staff (e.g. fire department) has been notified

## Resetting of zone

Example: Detector zone 3

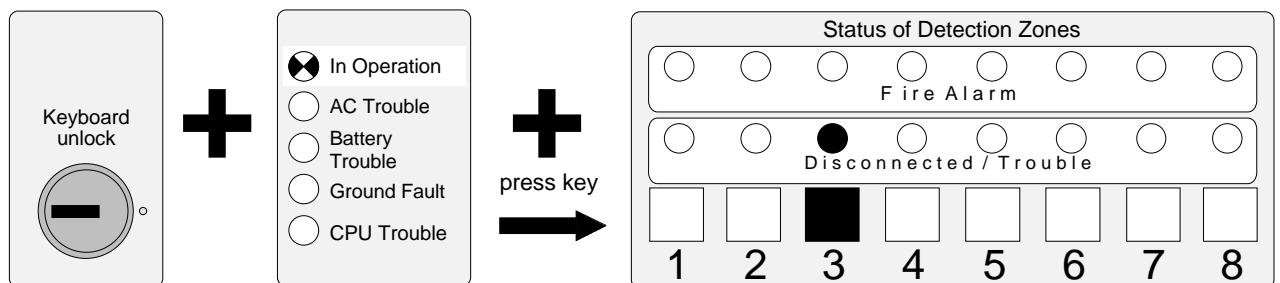

- Use the key switch to enable the key pad for operation
- Briefly keep the relevant detector zone key pressed
- Red LED deactivated, yellow LED will light up ⇒ detector zone is now disconnected
- Press key again
- Yellow LED deactivated ⇒ detector zone is now returned to normal mode

## 1.6. Delay/Verify

By pressing the *delay* key in normal function the delay function will be activated. Becomes now one fire detected so goes of the following example (Example: Detector zone 3)

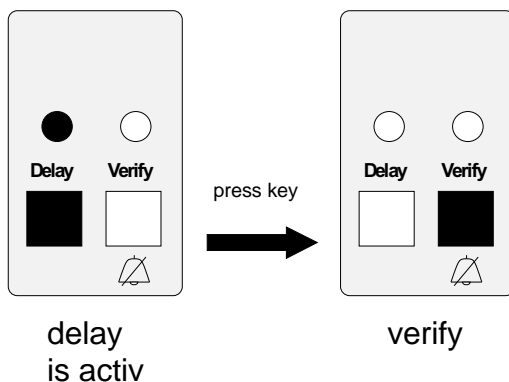

Master box MFAB will not be activated until **after** the programmed delay time has elapsed. (3 minutes max.)

If the verification function is selected while the delay time is running, the MFAB activation will be delayed additionally by this verification period (14 minutes max.). The cause of alarm may be "verified" during this period.

### Exception

Manual call points (connected to detector zones 1 and 2) will activate the master box (MFAB) immediately (without delay).

 Please ask your specialized installer for further details.



# ESSER

## 1.7. Alarm counter

The four-digit alarm counter is incremented automatically by one digit each time an alarm occurs, i.e., each time .

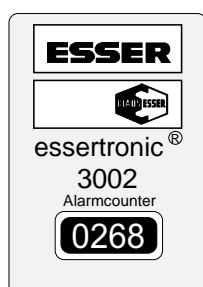

- a fire alarm is triggered
- an alarm event occurs in detector zones 5 and 6 if programmed for 2-zone dependency
- an alarm event occurs in detector zones 3 and 4 if programmed for alarm verification function

It is not possible to reset the alarm counter !

 The above-mentioned 2-zone dependency and alarm verification functions may be programmed to suit the configuration of the fire alarm system.  
Please ask your specialized installer for further details.

## 1.8. Lamp test

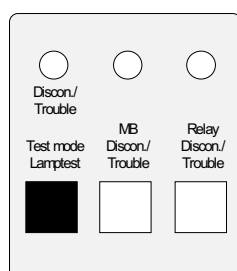

- Enable key pad
- Press test key
- Panel buzzer will sound
- All indicator LED's on the operating panel will light up for approx. 10 seconds

## 1.9. Common Trouble and CPU failure

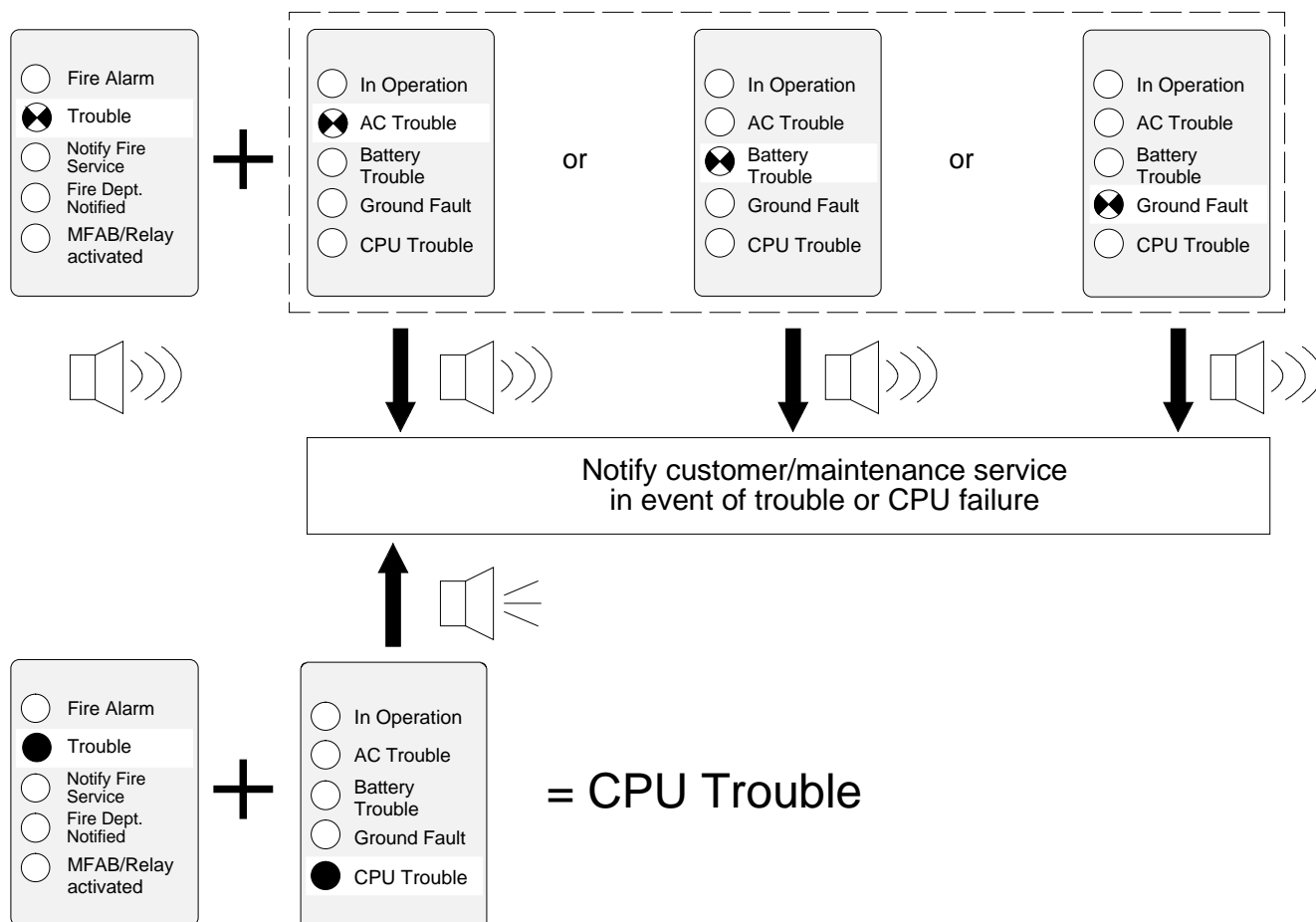

- Yellow LED *Trouble* will flash  $\Rightarrow$  trouble in one or more panel functions
- yellow LED *Trouble* and CPU Trouble are permanently on  $\Rightarrow$  the fire alarm control panel is only partially operative due to malfunction of the control panel functions (CPU trouble).
- The common trouble relay is activated

In case of CPU trouble the buzzer can be switched off. The CPU trouble is latched. It can only be reset in accesslevel 3 (housing open) about the key *CPU-trouble-off*.

 The activating of the master box (MFAB) and the LED *Notify fire department* is still operative in the CPU failure mode of the control panel in the case of a fire alarm.

## Trouble with detector zones

Example: Detector zone 5

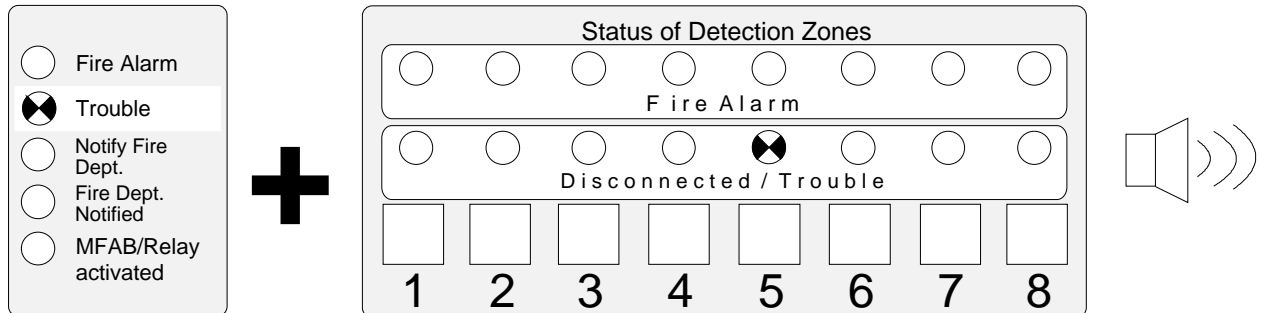

- Yellow LED flashes in common indicator section
- Yellow LED in the detector zone section indicates the detector zone that is malfunctioning.

 A malfunctioning detector zone will not signal any alarm in the event an alarm occurs

## Trouble with MFAB / relay output

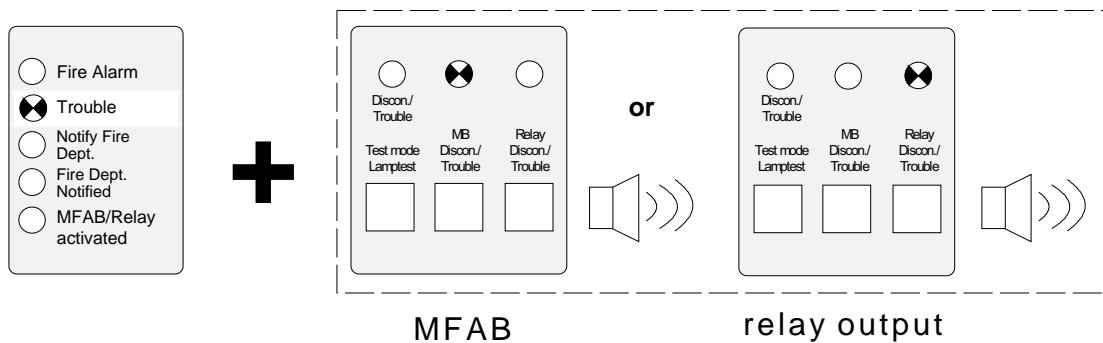

- Yellow LED flashes in common indicators section
- Yellow LED flashes for malfunctioning MFAB/relay output

 Alarm will not be relayed if an event occurs while MFAB/relay output is in trouble or disconnected!



# **ESSER**

Installation Manual  
essertronic<sup>®</sup> 3002 serie 02  
Fire Alarm Control Panel

Contents	Page
<b>2. Installation Manual</b> . . . . .	<b>15</b>
2.1. Regulations/guidelines . . . . .	15
2.2. Wall mounting . . . . .	16
2.3. Basic circuit board (overview) . . . . .	17
2.3.1.AC connection and function check . . . . .	18
2.4. Zone module . . . . .	19
2.4.1.Detector zone operating mode . . . . .	19
2.4.2.Wiring of detector zones . . . . .	20
2.4.3.Detector zone test mode (one-man revision) . . . . .	20
2.5 Transistor outputs (open collector) . . . . .	21
2.6. Relay outputs . . . . .	21
2.7. Connecting fire department operating panel (FDOP) . . . . .	25
2.8. Setting of DIL-switches. . . . .	26
2.8.1.Function of solder and plug-type jumpers . . . . .	28
2.9. Function of alarm verification (AV) . . . . .	29
2.10. Function of 2-zone dependency 2ZD . . . . .	30
<b>3. Technical specifications</b> . . . . .	<b>31</b>

## 2. Installation Manual

### 2.1. Regulations/guidelines

- Only install the fire alarm control panel in dry, clean, restricted-access and adequately illuminated rooms with an indoor atmosphere corresponding to DIN 50019-R14.
- Do not install system in work rooms that are exposed to harmful effects. Parts of the fire alarm system may be run through such work rooms if they meet the requirements under DIN/VDE 0800.
- When wall mounted, controls and visual indicators must be installed at a height of between 800 mm and 1800 mm above floor level.
- Avoid electrical or mechanical influences (interference)
- A separate power circuit with appropriately marked fuse (marked red, labeled "FACP") must be used for supplying AC power to the fire alarm control panel

It is necessary to **adhere to** and **observe** the following standards and guidelines:

DIN 14675	DIN/VDE 0800
DIN/VDE 0100	DIN/VDE 0833
DIN/VDE 0108	DIN/VDE 0845
DIN/VDE 0165	



Also observe the connection conditions and construction regulations of the local fire departments and building supervisory authorities.

## 2.2. Wall mounting

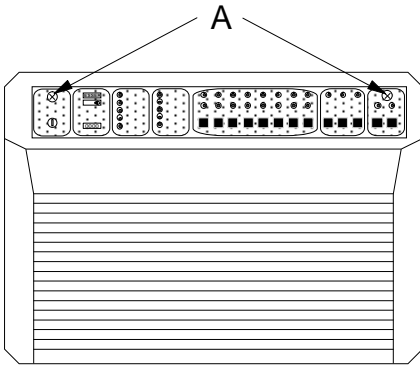

Remove screws "A"

The front cover of the two-part plastic housing may be removed at an angle of approx. 45° from retainers "B"

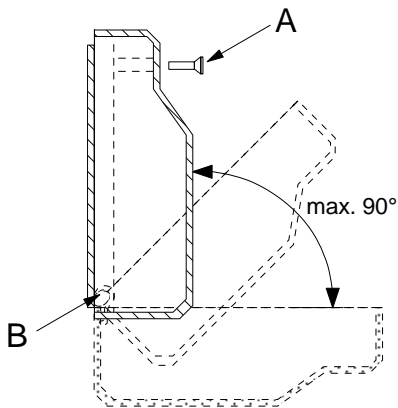

For wall mounting, drill 4 holes at points "C" and "D" into the wall

Insert plugs into drilled holes

Drive in the two upper screws half way and hang plastic housing

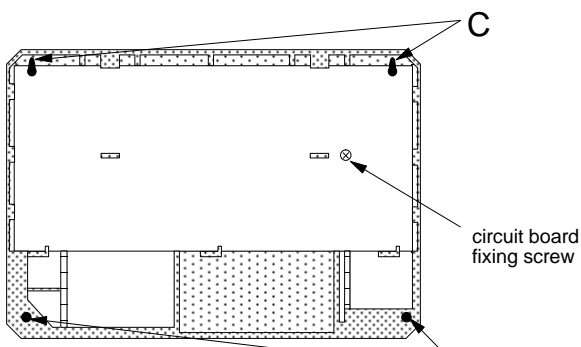

Drive in the two bottom screws and tighten all 4 screws

Avoid distorting the case or circuit board !



Only perform these work steps while panel is disconnected from any voltage supply!



## 2.3. Basic circuit board (overview)

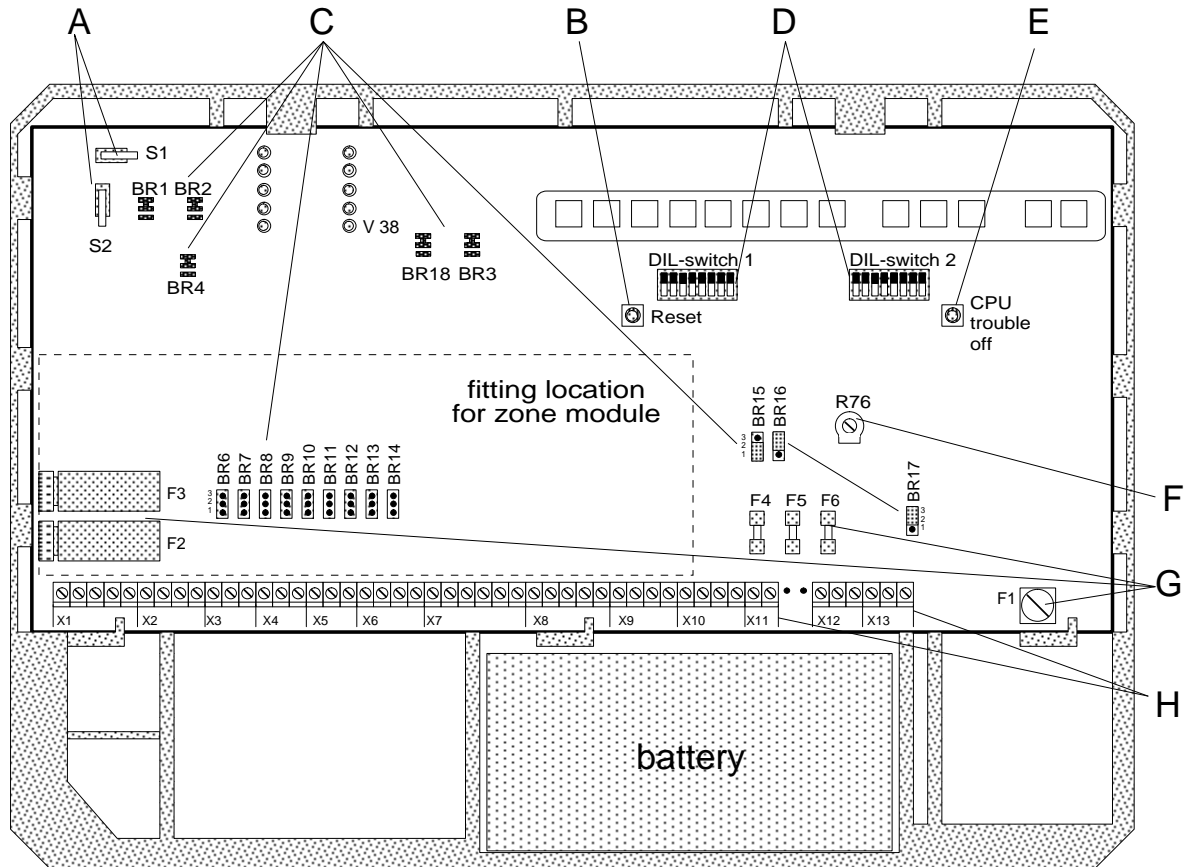

<b>A</b>	S1- housing contact, S2- key pad enable (key pad lock)																		
<b>B</b>	RESET key for resetting the panel (cold start) and test the CPU-trouble																		
<b>C</b>	Solder bridges and jumpers (functional description see section 2.8.1)																		
<b>D</b>	DIL-switches 1(S3) and 2 (S4) (see section 2.8)																		
<b>E</b>	CPU-trouble-off key for resetting the CPU-trouble																		
<b>F</b>	Potentiometer for adjusting battery charge output voltage 13.8 V DC																		
<b>G</b>	Fuses: <table style="display: inline-table; vertical-align: top; margin-left: 20px;"> <tr> <td>F1</td> <td>Primary fuse (AC)</td> <td>T 315 mA</td> </tr> <tr> <td>F2</td> <td>Master box</td> <td>T 1 A</td> </tr> <tr> <td>F3</td> <td>Alarm device</td> <td>T 1 A</td> </tr> <tr> <td>F4</td> <td>Detector zones</td> <td>T 2 A</td> </tr> <tr> <td>F5</td> <td>Battery</td> <td>T 2 A</td> </tr> <tr> <td>F6</td> <td>+ UB ext.</td> <td>T 1 A</td> </tr> </table>	F1	Primary fuse (AC)	T 315 mA	F2	Master box	T 1 A	F3	Alarm device	T 1 A	F4	Detector zones	T 2 A	F5	Battery	T 2 A	F6	+ UB ext.	T 1 A
F1	Primary fuse (AC)	T 315 mA																	
F2	Master box	T 1 A																	
F3	Alarm device	T 1 A																	
F4	Detector zones	T 2 A																	
F5	Battery	T 2 A																	
F6	+ UB ext.	T 1 A																	
<b>H</b>	Terminals for relay/transistor outputs, FDOP, MFAB connection, +UB ext. and GND																		

### 2.3.1. AC connection and function check

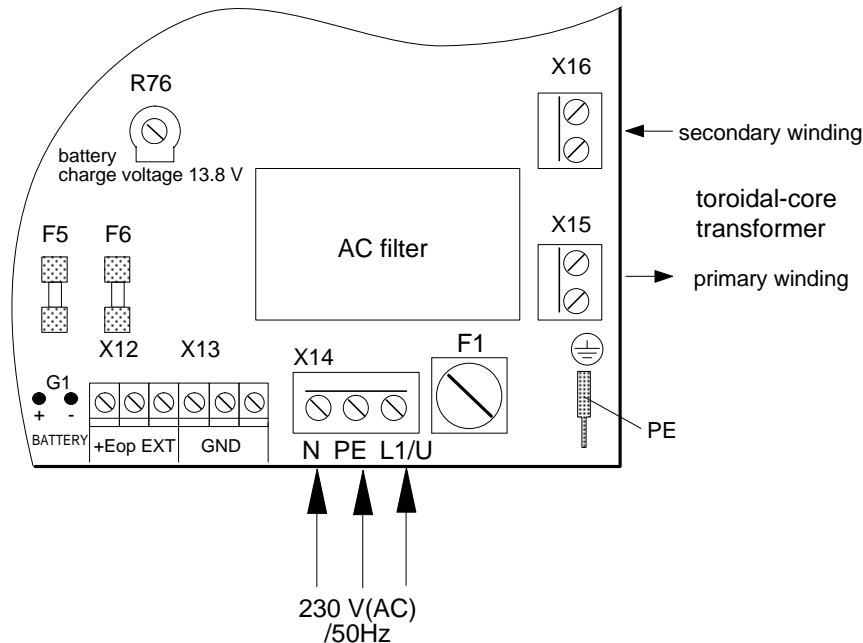

- Connect AC lead to main pc board. Keep length of mains cable inside the panel as short as possible.
- Connect main pc board via PE flat connector to equipotential bonding strip (PAS) in main distribution box. (Immunity of panel to interference will otherwise not be ensured)
- Fix zone module to main pc board using metal screws and spacers provided. Pay attention of PE connection to basic circuit board by means of metal screws !

#### Function check without external connection

The detector zone inputs and monitored relay output (K2) are factory-fitted with EOL (end-of-line) resistors (10k $\Omega$ ).

The MFAB relay (K1) is terminated with an equivalent resistance of 560 $\Omega$ .

- Connect AC and battery
- Close front cover (of housing) or keep housing switch S1 pressed (For position, refer to basic circuit board shown in Section 2.3)
- Test panel functions

## 2.4. Zone module

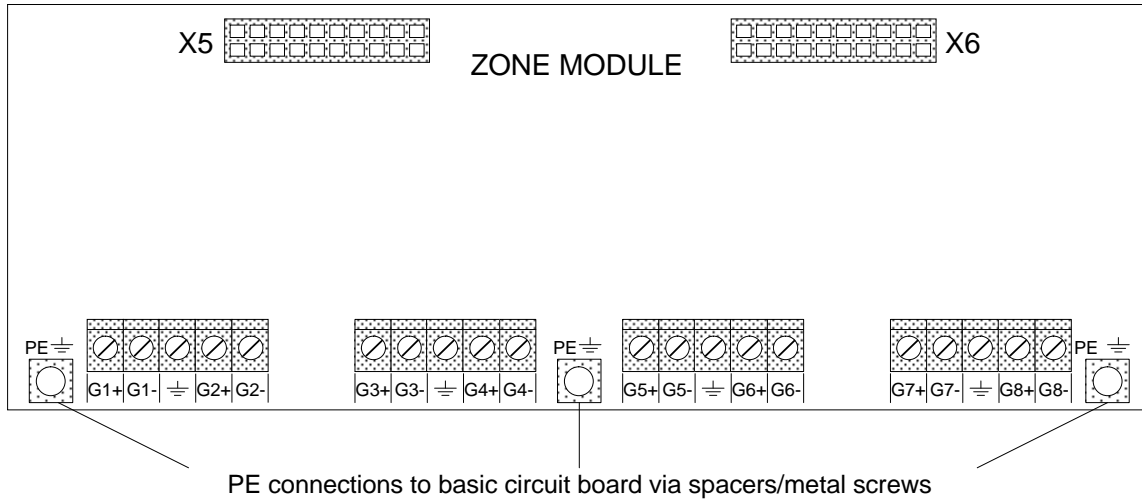

### 2.4.1. Detector zone operating mode

The operating mode of the detector zones is selected by means of the two DIL-switches S3 / S4 (see Section 2.8)

<b>Detector zone 1 and 2</b>	Standard detector zone <b>or</b> connection of manual call points (MCP) with direct master box activation. (No delay/verification function)
<b>Detector zone 3 and 4</b>	Standard detector zone <b>or</b> detector zone with alarm verification of 10 seconds Do not connect optical smoke detector !
<b>Detector zone 5 and 6</b>	Standard detector zone <b>or</b> detector zone with 2-zone dependency function (2ZD) At least one detector must trigger in detector zone 5 <b>and</b> 6 for an alarm to be transmitted
<b>Detector zone 7 and 8</b>	Standard detector zone without special function

EOL resistor for detector zones:

Normal mode	R = 10kΩ
Fire alarm	R = 1 kΩ (fire simulation)

## 2.4.2. Wiring of detector zones

Wiring examples with standard detector base 781490

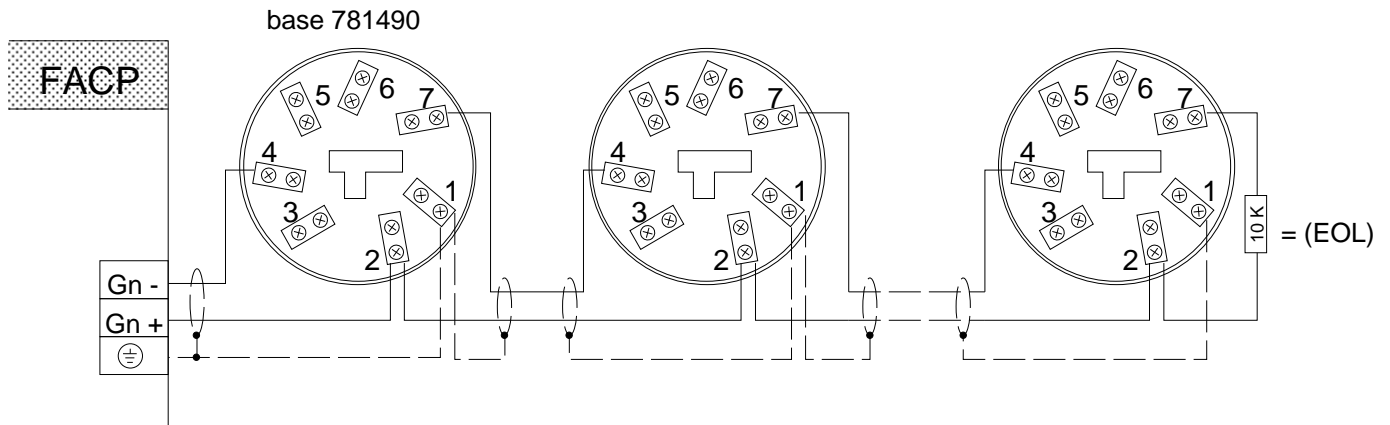

Recommended connecting cable: Line lengths up to 1000 m ⇒ J - Y(St)Y n x 2 x 0.8

Line lengths up to 500 m ⇒ J - Y(St)Y n x 2 x 0.6

👉 Observe maximum number of detectors per detector zone!

## 2.4.3. Detector zone test mode (one-man revision)

Example: Detector zone 3

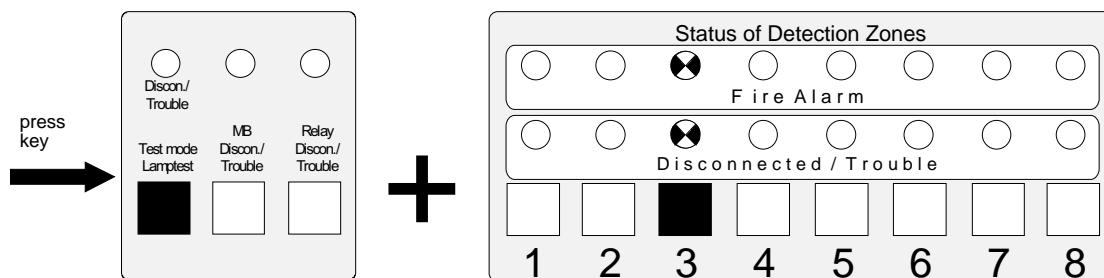

- Press test key
- Press key for detector zone you wish to switch into test mode
- Red and yellow LED for zone will flash alternately ⇒ detector zone in test mode
- Terminate test mode ⇒ press detector zone key once again

👉 Only one detector may be in test mode at a time!

## 2.5. Transistor outputs (open collector)

The zone-related transistor outputs (A1 to A8) will be activated when the relevant detector zone is in alarm.

An additional indicator - e.g., remote alarm indicator panel - may be connected to these outputs for each individual detector zone.

- 8 positive-switching open collector outputs
- 12 V DC / max. 200 mA
- short-circuit-protected (current limited)

### Example using transistor outputs A1, A3 and A5

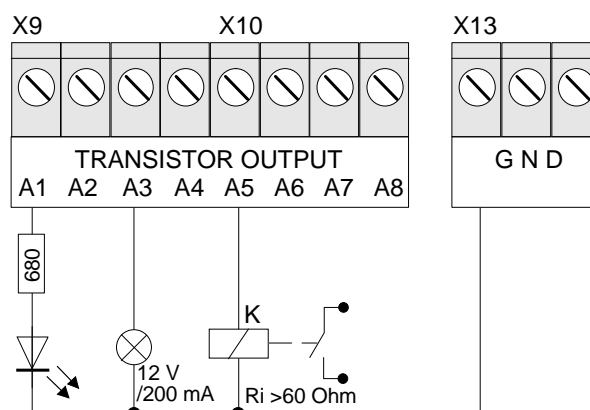

## 2.6. Relay outputs

Relay	Application	Monitored	Potential-free	positiv-switching
K1	MFAB relay output	yes*	yes	yes*
K2	Remote alarm devices (relay output)	yes*	yes	max. contact rating 30V/1A
K3	Common fire	no	yes	
K4	Common trouble	no	yes	
K5	Common disconnection	no	yes	
K6	Fire department is notified or free function selection	no	yes	

\* monitored/potential-free/positiv-switching operating mode freely selectable by means of plug-type jumpers.

## MFAB relay (K1)

The MFAB relay is activated in the event of a fire alarm and will trigger the interfaced master box.

Confirmation from the master box is indicated by the LED "Fire department is notified". If no confirmation is received from the master box or if no master box has been connected, operating panel - LED "Notify fire department" will light up !

### monitored

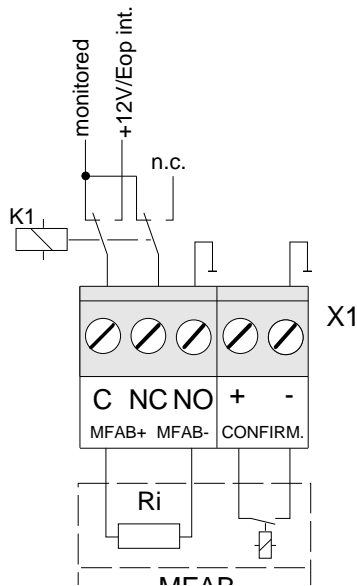

#### monitored operating mode

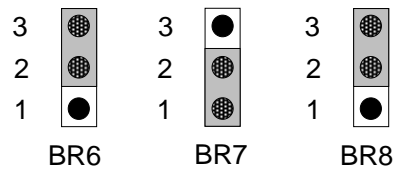

#### resistance range for MFAB:

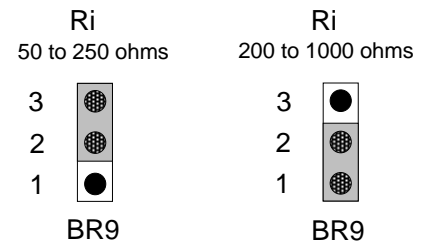

### positive-switching / not monitored

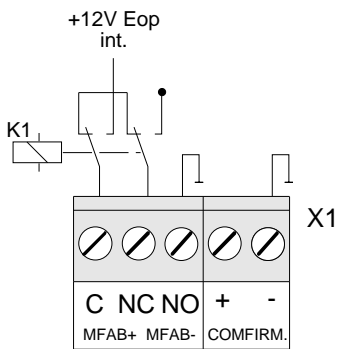

#### positive-switching operating mode

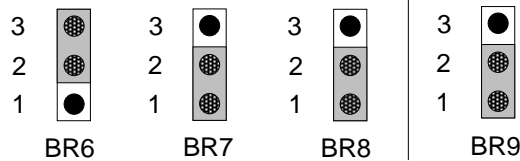

### potential-free

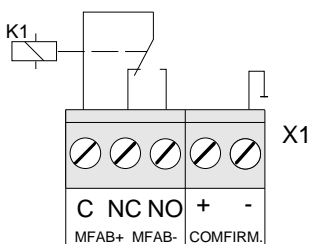

#### potential-free operating mode

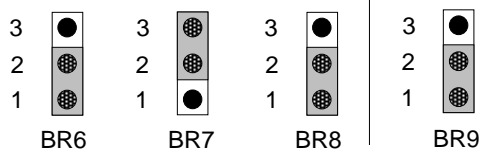

# ESSER

## Relay output(K2)

The relay output K2 is activated in the event of a fire alarm.

Remote alarm devices - either monitored or potential-free - are connected to this relay for audible or visual indication.

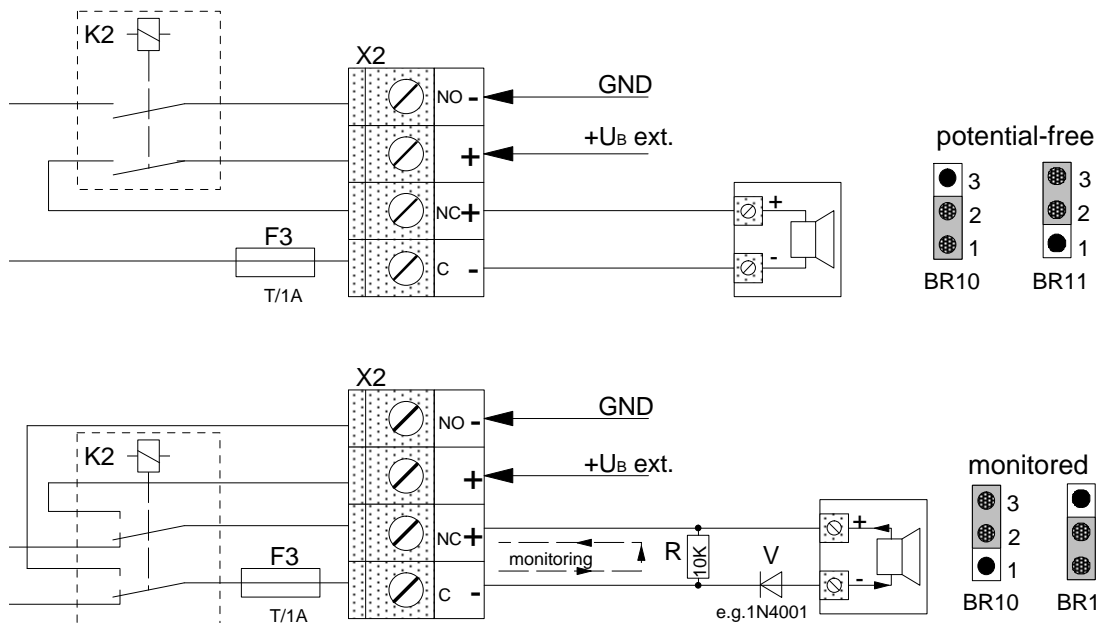

## Common fire alarm (K3)

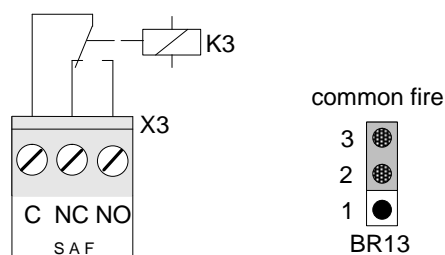

The common fire alarm relay will be activated if at least one fire is indicated on the fire alarm control panel.

## Common trouble (K4)

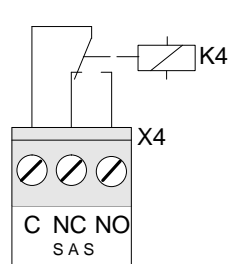

The common trouble relay is activated permanently while fire alarm control panel is in normal operating mode.

Activation will be interrupted in the event of CPU failure or at least one trouble signal to the control panel.

This is to ensure that a signal can still be transmitted in the event of battery or mains voltage failure.

### Common disconnection (K5)

The common disconnection relay is activated at every disconnection, e.g. detector zone.

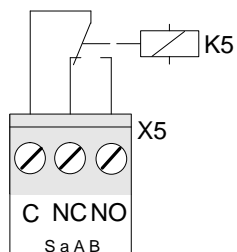

### Fire department notified/ free function selection (K6)

**Fire department notified :** The relay will be activated after confirmation from triggered master box.

Used, e.g., for opening the fire department key box

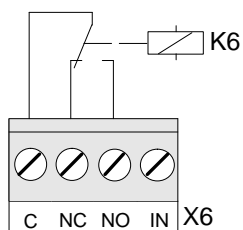

Fire departement notified

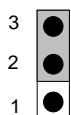

BR12

**Free function:**

The relay may be used for any function through remote activation - either +12 V DC or 0V at terminal X6 IN.

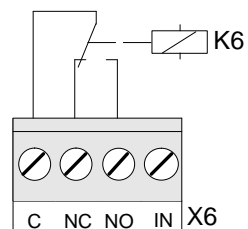

unassigned function

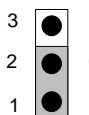

BR12

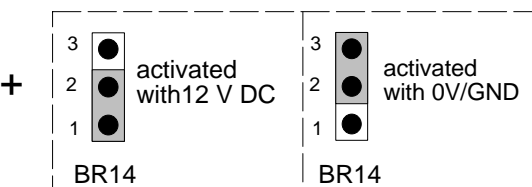



## 2.7. Connecting fire department operating panel (FDOP)

Terminals on basic circuit board

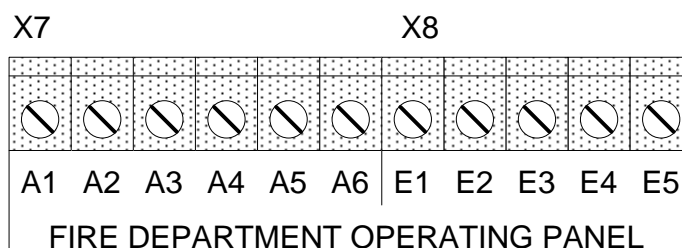

### Terminal assignment

Outputs		
A1	MFAB triggered	positive-switching, 12 V DC max. 20 mA
A2	MFAB disconnected	
A3	Disconnect audible alarm	
A4	Exting. system triggered	
A5	Notify fire department	
A6	Common fire	
Inputs		
E1	fire department - revision	low-active, switched to 0V/GND
E2	Disconnect MFAB	
E3	Test MFAB	
E4	Reset FACP	
E5	Disconnect audible alarm	

## 2.8. Setting of DIL-switches

### DIL-switch 1 (S3)

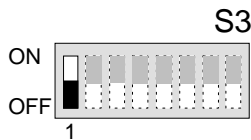

**ON** 1 minute verification time  
**OFF** No verification time

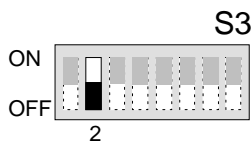

**ON** 2 minutes verification time  
**OFF** No verification time

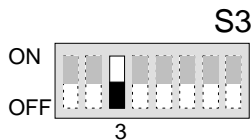

**ON** 4 minutes verification time  
**OFF** No verification time

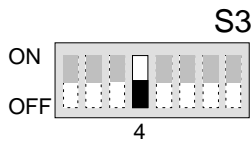

**ON** 8 minutes verification time  
**OFF** No verification time

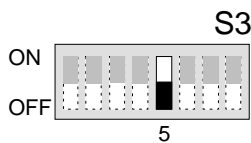

**ON** 1 minute delay time  
**OFF** No delay time

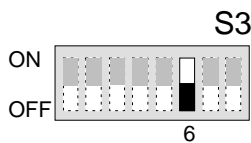

**ON** 2 minutes delay time  
**OFF** No delay time

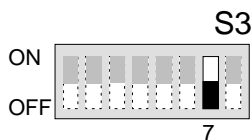

**ON** Detector zone 1 with manual call points (MCP) and direct activation of master box  
**OFF** Standard detector zone 1

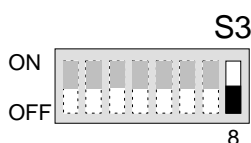

**ON** Detector zone 2 with manual call points (MCP) and direct activation of master box  
**OFF** Standard detector zone 2



### Special function

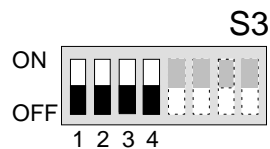

**ON** no MFAB activated (relay K1)

# ESSER

## DIL-switch 2 (S4)

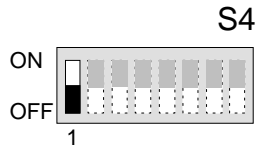

**ON** Detector zone 3 with alarm verification (AV)

**OFF** Standard detector zone 3

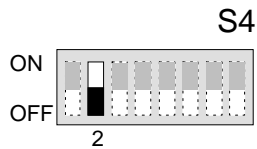

**ON** Detector zone 4 with alarm verification (AV)

**OFF** Standard detector zone 4

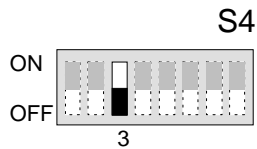

**ON** Detector zones 5 and 6 in 2-zone dependency (2ZD)

**OFF** Standard detector zone 5 and 6

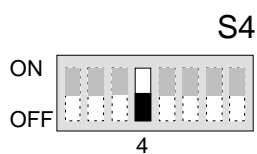

**ON** AC failure only signaled by buzzer and relay activation delayed for 30 minutes.  
(AC failure LED will be activated immediately)

**OFF** No delay in signaling activations

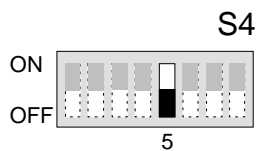

**ON** Intermittent activation of master box (6 seconds)

**OFF** Continuous MFAB activation

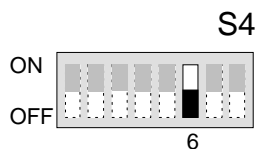

**ON** Fire department operating panel (FDOP) connected

**OFF** No fire department operating panel connected

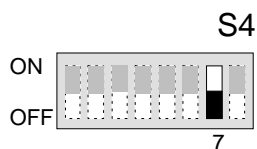

**ON** Not used

**OFF** Not used

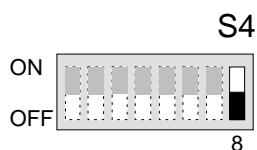

**ON** Panel buzzer activated upon alarm and trouble as well as audible confirmation of control actions

**OFF** Panel buzzer disconnected - no activation

### 2.8.1. Function of solder and plug-type jumpers

Jumper	Function	
BR 1 / BR 2	MFAB disconnected when housing contact open (factory setting)	
	No MFAB disconnection	
BR 3	Delay key always operational (factory setting)	
	Delay key inhibited by key switch	
BR 4	For factory use only (EPROM)	do not alter
BR 6	For setting operating mode of MFAB relay (K1)	see Section 2.6 Relay outputs
BR 7		
BR 8		
BR 9		
BR 10	Setting operating mode of relay output(K2)	see Section 2.6 Relay outputs
BR 11		
BR 12	Setting operating mode of relay K6 - Notify fire department / free function (see BR 14)	see Section 2.6 Relay outputs
BR 13	Setting operating mode of common fire relay (K3)	
BR 14	Remote activation of relay K6 (0V/12V)	
BR 15	Factory setting (do not alter)	
BR 16		
BR 17	Ground fault detection	
BR 18	For changing color of LED indicator of "relay output activated" (V38)	

## 2.9. Function of alarm verification (AV)

Detector zone 3 and 4

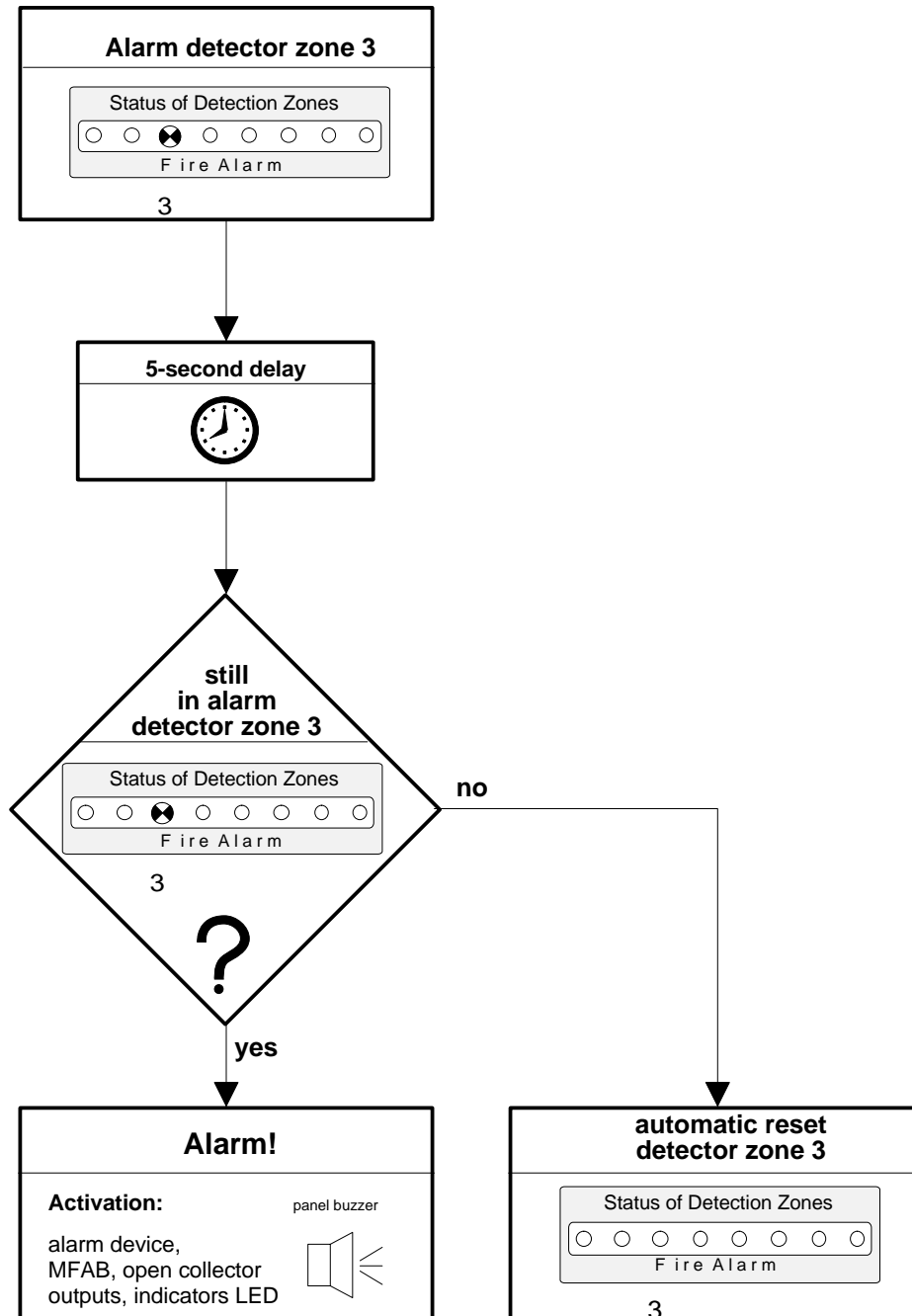

Observe position of DIL-switches!

## 2.10. Function of 2-zone dependency 2ZD

Detector zones 5 and 6

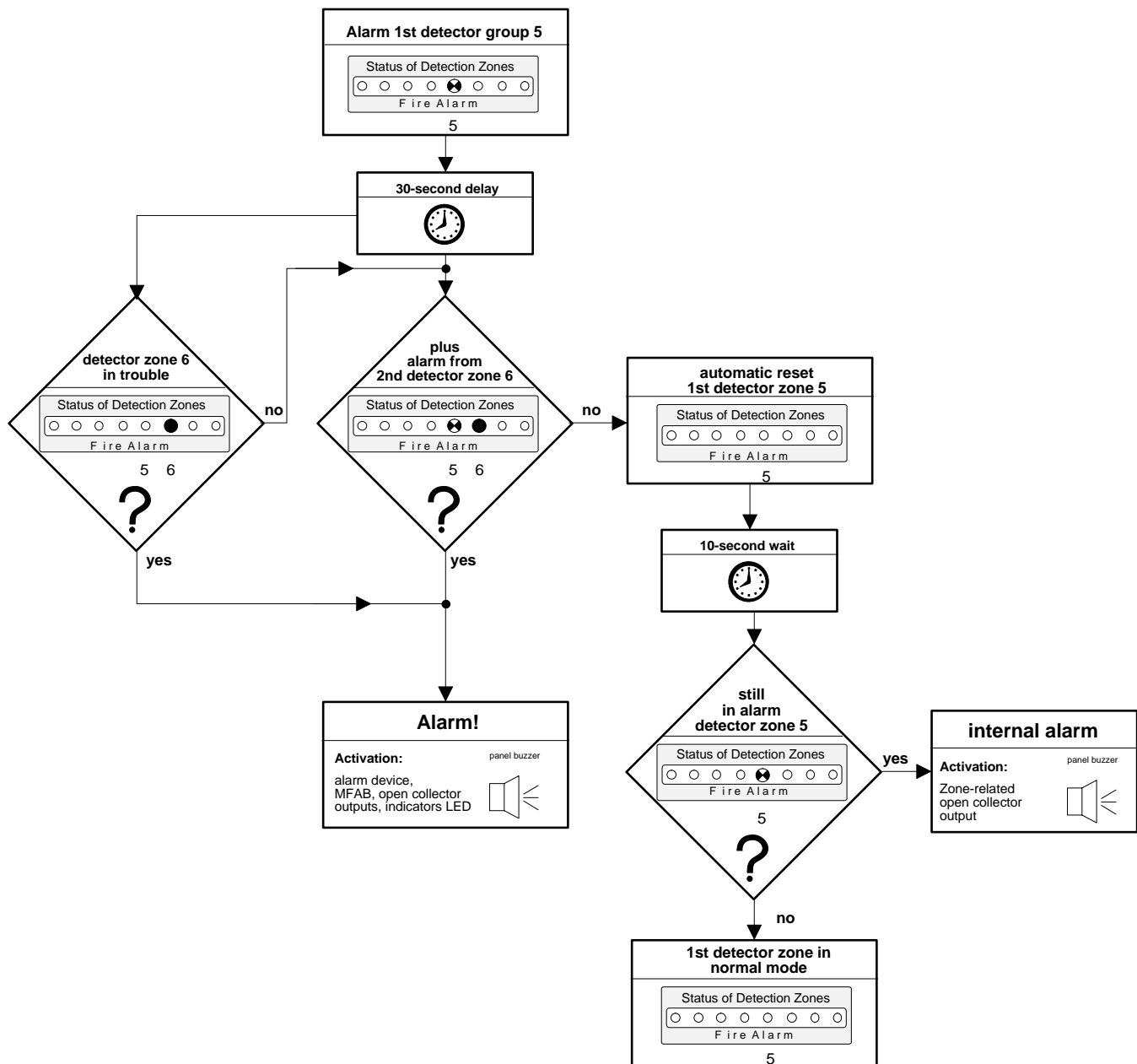

 Observe position of DIL-switches!

## 3. Technical specifications

VdS-Approval	:	G 293028 / G296053 (DIN EN 54 part 2/4)
Operating voltage	:	230 V AC/ 50-60 Hz
Rated voltage	:	12 V DC
Rated power	:	45 VA
Battery	:	12 Ah max.
Quiescent current	:	80 mA (with 1x common trouble relay and 1 x Operation LED)
Max. current for remote devices	:	1 A
Detector zone voltage	:	typical 9 V DC
Max. detector zone current	:	240 mA, short-circuit-protected (current limited)
Transistor outputs	:	Max. 200 mA, 12 V DC, current limited, positive-switched
Fuses	:	F1 Primary fuse (AC) T 315 mA F2 Master box T 1 A F3 Alarm device T 1 A F4 Detector zones T 2 A F5 Battery T 2 A F6 + U <sub>B</sub> ext. T 1 A
Contact rating of relays	:	30 V / 1 A
Indicators	:	LED power consumption typical 2 mA/LED
Buzzer	:	12 V/5 mA
Monitoring voltage MFAB	:	120 mV (at 50 Ω) to 680 mV (at 1kΩ)
Output 1 to 6 for FDOP	:	12 V DC, max. 20 mA positive-switched (not protected)
Ambient temperature	:	0 °C to +50 °C
Storage temperature	:	-10 °C to +60 °C
Type of protection	:	IP 30EN 60529 / DIN VDE 0470 T1
Protection class	:	II DIN EN 60950 A1 + A2
Room climat class	:	R 14 (DIN 50019)
Housing	:	ABS plastic
Colour	:	Light gray (RAL 7035)
Weight	:	Approx. 3.0 kg (without battery)
Dimensions (wxhxd)	:	364 x 367 x 121 (mm)
CE	:	DIN EN 50081 part 1 + 2 DIN EN 50082 part 1 + 2 NSR

